

## Research Article

# Online Identification of Distribution Line Parameters by PMUs under Accuracy, Positive Sequence, and Noise Considerations

Mustafa M. Al Khabbaz <sup>1</sup> and Mohamed A. Abido <sup>2</sup>

<sup>1</sup>Facilities Planning Department, Saudi Arabian Oil Company (Saudi Aramco), Dhahran 31311, Saudi Arabia

<sup>2</sup>Electrical Engineering Department, King Fahd University of Petroleum and Minerals, Dhahran 31261, Saudi Arabia

Correspondence should be addressed to Mustafa M. Al Khabbaz; am.1@hotmail.com

Received 19 August 2018; Revised 27 October 2018; Accepted 15 November 2018; Published 20 December 2018

Academic Editor: Salvatore Favuzza

Copyright © 2018 Mustafa M. Al Khabbaz and Mohamed A. Abido. This is an open access article distributed under the Creative Commons Attribution License, which permits unrestricted use, distribution, and reproduction in any medium, provided the original work is properly cited.

This paper proposes an inaccuracy mitigation measure to reduce the error associated with distribution line parameters identification. Additionally, it introduces the concept of positive sequence quantities for determining the line resistance, reactive inductance, and shunt admittance. The positive sequence-based analysis is required for asymmetrical related studies such as unbalanced fault analysis. The paper, also, includes the consideration of noisy distribution networks. It compares the performance of three line parameters identification techniques by using different statistical measures. A total of 12,960 different case studies are simulated and analyzed under six main loading scenarios and four categories with changing line parameters. The line parameters are calculated online using voltage and current signals obtained from phasor measurement units (PMUs) placed at the line two terminals. Finally, the study outcomes and the associated recommendations have been summarized for future works considerations.

## 1. Introduction

Distribution line (DL) parameters identification forms the basis for distribution power system studies, including dynamic and transient stabilities, state estimate, protection setting, etc. The common practice in the industry, till today, is to determine the parameters using values from design datasheets, manufacture specification sheets, and engineer estimation. The latter could base the calculation on conductor dimensions, sag, temperature, tower geometries, and other elements. These elements are used to identify the DL data through different mechanisms such as calculating the geometric mean radius and the geometric mean distance, denoted by GMR and GMD, respectively. Additionally, the official electrical transient analysis program (known as ETAP) model could be utilized to find the DL data, which is an off-line tool. Assumptions and approximations are included in the calculation process steps which reduce the accuracy of results. Basing DL parameter estimation on off-line techniques or preidentified information significantly

impacts the accuracy level of the power system studies that depend on these values due to the following:

- (1) Conductor resistance and reactance vary with ambient conditions, conductor situation, and power flow.
- (2) A number of installed circuits are spliced with other conductors that are different in types and specifications. This represents an inhomogeneity of the line sections.
- (3) The overhead conductor arrangement changes due to using different tower configurations and applying the concept of transposition.
- (4) Cable installation conditions such as grouping, underground, overhead, cable trays, conduits, and submarine, etc., play a major role in line parameter estimation.
- (5) Cable aging could impact the line parameters due to several factors such as degradation, tension, and life cycle.

The above five factors are sources of conductor impedance and admittance identification errors. With the emergence of PMU technology, it is possible to obtain more accurate data about the system conditions with high-frequency samples along with the corresponding time stamp. Accordingly, it is possible to develop more accurate DL impedance parameters estimation by online measurement techniques using the synchronized PMUs. This online analysis can be used to improve power system operations reliability as detailed below:

- (a) Power system restoration and reclosing: phasor data is used to bring equipment back into service avoiding the risk of instability or unsuccessful reclosing trials
- (b) Automated management of voltage and frequency response: the data is used for better system management to frequency and voltage changes
- (c) Wide-area protection: real-time phasor data allows for improved grid events identification and execution of appropriate system protection measures
- (d) Planned power system islanding: this is to improve islanding of power system during instability situations
- (e) Power plant monitoring and integration: real-time data is used for better integration of different power plants that includes intermittent renewables or distributed power sources

The majority of research works to estimate the power system line parameters are focused on transmission systems. Numerous techniques have been introduced to calculate the transmission parameters using the synchronized measurement devices. A two-port ABCD parameter identification based technique was introduced in [1]. This method utilized two sets of three samples of sending and receiving terminals' voltage and current signals. This was to find three estimates of ABCD parameters. The ABCD method is referred to in this research work as a "two-port circuit measurement technique". In Reference [2], four methods were discussed to identify short transmission line parameters by synchronized measurements. Reference [3] proposed a novel method to identify transmission line parameters for different cases, including short and long, transposed and untransposed lines with balanced and unbalanced load conditions. The positive sequence line parameters considering the effects of the line shunt capacitance were estimated in [4], employing a two-terminal transmission line model. Likewise, Reference [5] aimed to achieve the same objectives where a new estimation method was presented using synchronized phasor measurements at both line ends. The approach in [6] proposes the use of recursive parameter estimation to find the network branch parameters online and off-line. The least-square technique was leveraged in [7] with the objective of obtaining the line parameters iteratively.

Unlike the abundance of publications on transmission line parameters estimation, the work in distribution is limited. The probability theory, which builds on voltage drop linear equivalent model, was used in [8]. The approach objective was to estimate the DL impedance and get precise parameters. Numerous works discussed the uncertainties of network parameters and inaccuracy of measurements.

In particular, the DL parameters and measurement uncertainties were analyzed in [9]. A novel power system uncertainty analysis technique was proposed in [10], where a two-step approach based on static weighted least-squares analysis was used. Reference [11] presents a method to estimate distribution line parameters using only conventional SCADA measurements (voltage magnitude and power measurements). It resulted in a negligible deviation between simulation, experiment, and the actual manufacturer specifications. The key outcomes of the DL parameters estimation studies were that the accuracy of line parameters is crucial for a number of applications including the grid control, stability analysis, and fault location studies.

To the best of the authors' knowledge, the applicability of different methods to identify the sequence DL parameters has not been considered before. This paper proposes the use of PMU to identify the DL parameters under the consideration of accuracy, positive sequence, and noise. The concept of symmetrical components is leveraged to extract the positive sequence of the synchronized phasor voltage and current measurement signals. The online synchronized signals obtained from the PMUs will be used in calculating both the phase and positive sequence DL parameters. In Section 2, three techniques have been developed to measure DL resistance, reactive inductance, and shunt admittance. Section 3 describes the used accuracy statistical measures to evaluate and compare the performance of the three techniques. The developed case studies along with their results and discussion are presented in Sections 4 and 5, respectively. Finally, the study recommendations and outcomes are stipulated in Section 6. The main data used to support the findings of this study are included within this article. If additional data is required, it could be requested from the corresponding author with proper justification.

## 2. Techniques of Distribution Line Parameters Estimation

Three different techniques are discussed in this section with the objectives of identifying the DL parameters. The techniques leverage the PMU voltage and current signals obtained at the two terminals of the line. In order to perform DL parameters estimation, the line is represented in a  $\pi$ -model equivalent circuit as illustrated in Figure 1(a).

The study considers the positive sequence of the voltage and current phasors in addition to the phase values. This aims to explore accuracy enhancement opportunities and compare the results. Additionally, the sequence quantities are required for developing any asymmetrical analysis. The positive sequence equivalent  $\pi$ -model is shown in Figure 1(b).

*2.1. Ohm's Formula Technique.* The proposed ohm's formula technique (OFT) depends on the ohm's law [12]. Under this method, both phase and positive sequence voltage and current phasors are used. This method requires only single set of voltage and current samples of the phasor voltage and current signals produced by PMUs.

The developed OFT equations to calculate the DL parameters are described below:

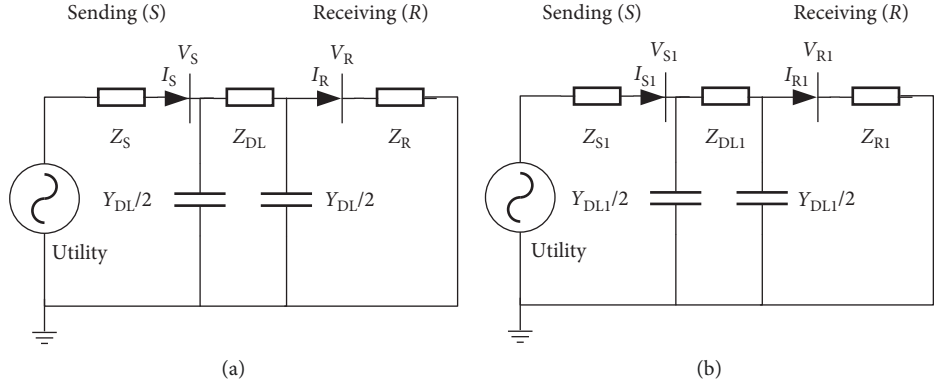

FIGURE 1: Distribution line equivalent model ( $\pi$ -Type). (a) One-line diagram using the phasor quantities (b) One-line diagram using the positive sequence quantities. The parameters of the above circuits are described as follows:  $Z_S$ , equivalent impedance at the source side;  $Z_{S1}$ , positive sequence equivalent impedance at the source side;  $Z_R$ , equivalent impedance at the receiving end;  $Z_{R1}$ , positive sequence equivalent impedance at the receiving end;  $Z_{DL}$ , distribution line impedance;  $Z_{DL1}$ , positive sequence distribution line impedance;  $Y_{DL}$ , distribution line admittance;  $Y_{DL1}$ , positive sequence distribution line admittance;  $V_S$ , phase voltages at sending end;  $V_{S1}$ , positive sequence phase voltages at sending end;  $V_R$ , phase voltages at receiving end;  $V_{R1}$ , positive sequence phase voltages at receiving end;  $I_S$ , Phase current at sending end;  $I_{S1}$ , positive sequence phase current at sending end;  $I_R$ , phase current at receiving end;  $I_{R1}$ , positive sequence phase current at receiving end.

$$\begin{aligned} Z_{DL1} &= \frac{2(V_{S1} - V_{R1})}{I_{R1} + I_{S1}}, \\ Y_{DL1} &= \frac{I_{S1} - I_{R1}}{V_{S1}}. \end{aligned} \quad (1)$$

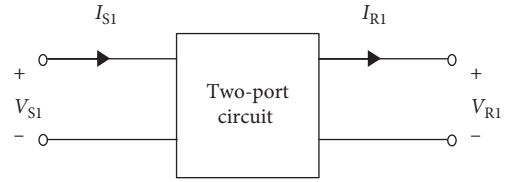

FIGURE 2: Representation of positive sequence two-port circuit for distribution line.

**2.2. Single Measurement Technique.** The proposed single measurement technique (SMT) aims to find DL resistance, reactive inductance and shunt admittance [12]. It uses both the phase and positive sequence of the voltage and current signals that are obtained from PMUs at the steady state. The SMT equations are formulated as follows:

$$\begin{aligned} Z_{DL1} &= \frac{V_{S1}^2 - V_{R1}^2}{V_{R1}I_{S1} + V_{S1}I_{R1}}, \\ Y_{DL1} &= \frac{2(V_{S1} - V_{R1})}{I_{R1} + I_{S1}}. \end{aligned} \quad (2)$$

**2.3. Two-Port Circuit Measurement Technique.** The two-port circuit measurement technique (TPCMT) requires two sets of synchronized measurement samples at different loading conditions [12]. The samples are taken from the DL terminals to calculate the two-port circuit parameter known as A, B, C, and D. The DL impedance and admittance are identified from the ABCD matrix.

The TPCMT is conventionally used to represent transmission lines. Additionally, it provides adequate accuracy for DLs at some cases. Representation of positive sequence TPCMT for DL is shown in Figure 2, where  $V_{S1}$ ,  $V_{R1}$ ,  $I_{R1}$ , and  $I_{S1}$  are the positive sequence of the sending and receiving ends voltage and current signals, respectively.

The following equations form the relation between the sending end and the receiving end quantities:

$$\begin{aligned} V_{S1} &= A V_{R1} + B I_{R1}, \\ I_{S1} &= C V_{R1} + D I_{R1}, \end{aligned} \quad (3)$$

where the parameters A, B, C and D are influenced by the DL resistance, inductance, capacitance, and conductance. The ABCD parameters are complex numbers in which A and D are unit less, B is measured in ohms, and C has a unit of Siemens.

The ABCD parameters of the DL equivalent  $\pi$ -model shown in Figure 1 are obtained by the following equations:

$$\begin{aligned} V_{S1} &= V_{R1} + Z_{DL1} \left( I_{R1} + \frac{V_{R1} Y_{DL1}}{2} \right) \\ &= \left( 1 + \frac{Z_{DL1} Y_{DL1}}{2} \right) V_{R1} + Z_{DL1} I_{R1}. \end{aligned} \quad (4)$$

By applying the Kirchhoff current law (known as KCL) at the sending end, the following equation is obtained:

$$I_{S1} = I_{R1} + \frac{Y_{DL1} (V_{R1} + V_{S1})}{2}. \quad (5)$$

Combining the previous two equations yields

$$\begin{aligned} I_{S1} &= I_{R1} + \frac{Y_{DL1} V_{R1}}{2} + \left[ \left( 1 + \frac{Z_{DL1} Y_{DL1}}{2} \right) V_{R1} + Z_{DL1} I_{R1} \right] \frac{Y_{DL1}}{2} \\ &= Y_{DL1} \left( 1 + \frac{Z_{DL1} Y_{DL1}}{4} \right) V_{R1} + \left( 1 + \frac{Z_{DL1} Y_{DL1}}{2} \right) I_{R1}. \end{aligned} \quad (6)$$

Comparing the last above formula with the ABCD equations yields

$$\begin{aligned} A &= D \\ &= \left(1 + \frac{Z_{DL1} Y_{DL1}}{2}\right) \text{ per unit,} \\ C &= Y_{DL1} \left(1 + \frac{Z_{DL1} Y_{DL1}}{4}\right) \text{ ohm.} \end{aligned} \quad (7)$$

From the simple DL (only series impedance representation) analysis and derivation B is obtained to be

$$B = Z_{DL1} \text{ ohm.} \quad (8)$$

The above A, B, C and D equations are solved to find  $Z_{DL1}$  and  $Y_{DL1}$  which will be as follows:

$$\begin{aligned} Z_{DL1} &= B \text{ ohm,} \\ Y_{DL1} &= \frac{2(A-1)}{B} \text{ Siemens.} \end{aligned} \quad (9)$$

This method could be extended to accommodate two sets of PMU measurements. The two sets could be obtained from two different redundant PMUs or from two readings recorded at different timing or loading conditions. The ABCD equations for the two sets are as follows:

$$\begin{aligned} V'_{S1} &= A V'_{R1} + B I'_{R1}, \\ I'_{S1} &= C V'_{R1} + D I'_{R1}, \\ V''_{S1} &= A V''_{R1} + B I''_{R1}, \\ I''_{S1} &= C V''_{R1} + D I''_{R1}. \end{aligned} \quad (10)$$

The samples of the voltages and currents for the receiving and sending ends are as the following:

- (i)  $V'_{S1}$ ,  $V'_{R1}$ ,  $I'_{S1}$ , and  $I'_{R1}$  are for the first set
- (ii)  $V''_{S1}$ ,  $V''_{R1}$ ,  $I''_{S1}$ , and  $I''_{R1}$  are for the second set

The ABCD parameters are calculated to account for the two sets to be as follows:

$$\begin{aligned} A &= \frac{I'_{R1} V'_{S1} - I''_{R1} V'_{S1}}{I'_{R1} V''_{R1} - I''_{R1} V'_{R1}}, \\ B &= \frac{V''_{R1} V'_{S1} - V'_{R1} V''_{S1}}{I'_{R1} V''_{R1} - I''_{R1} V'_{R1}}, \\ C &= \frac{I'_{R1} I''_{S1} - I''_{R1} I'_{S1}}{I'_{R1} V''_{R1} - I''_{R1} V'_{R1}}, \\ D &= \frac{I'_{S1} V''_{R1} - I''_{S1} V'_{R1}}{I'_{R1} V''_{R1} - I''_{R1} V'_{R1}}. \end{aligned} \quad (11)$$

### 3. Accuracy Statistical Measures

The accuracy of the proposed methods is evaluated using different statistical measures. This is to ensure that the measures will converge for all case studies analyzed in this paper.

That is, in case one statistical measure fails to perform in one of the cases, the evaluation will be achieved by the other measures.

**3.1. Percentage Error.** The first step toward accepting or rejecting the proposed methods is assessing its accuracy using the percentage error given by the following equation:

$$\text{error (\%)} = \frac{|\text{actual values} - \text{calculated value}|}{\text{actual value}} \times 100. \quad (12)$$

**3.2. Coefficient of Determination.** The coefficient of determination (CoD), denoted by  $R^2$ , is used to indicate the difference of the obtained values by a proposed formula compared to the actual ones. It measures the strength of the proposed formula and benchmarks it with the ideal situation which will result in a coefficient of determination of 100%. It is, also, called the squared error which is the error between the curve obtained by the proposed formula and the actual curve. The range of coefficient of determination varies between 0 and 1. The higher the number means the proposed formula is more descriptive and reflective to the actual values. Figure 3 is an explanatory sketch for calculating the CoD.

The coefficient of determination equation is formulated as follows:

$$\begin{aligned} \text{CoD} &= 1 - \frac{\sum_1^k (y_{\text{calc}} - y_{\text{act}})^2}{\sum_1^k (y_{\text{calc}} - \overline{y_{\text{act}}})^2} \\ &= 1 - \frac{\text{SE}}{\text{TV}}, \\ \text{SE} &= \sum_1^k (y_{\text{calc}} - y_{\text{act}})^2, \\ \text{TV} &= \sum_1^k (y_{\text{calc}} - \overline{y_{\text{act}}})^2. \end{aligned} \quad (13)$$

The parameters are described as follows: CoD, coefficient of determination; SE, total square error between the calculated points and the actual values; TV, total variation between the calculated points and the actual values;  $\overline{y_{\text{act}}}$ , mean of the actual values;  $y_{\text{calc}}$ , calculated value; and  $y_{\text{act}}$ , actual value.

**3.3. Other Accuracy Statistical Measures.** Other accuracy statistical measures are required to be integrated with the percentage error and CoD. This is due to the fact that the percentage error does not represent the correlation and the CoD has certain shortfalls, especially for small scientific numbers.

The following additional statistical measures are used to evaluate the proposals presented in this paper:

- (1) Mean absolute deviation (MAD), which is the summation of the absolute deviation between the actual and calculated values over the number of records (or the length of the range)
- (2) Mean square error (MSE), which is considered as the most common error metric. It is mainly the summation of the squared errors over the number of records

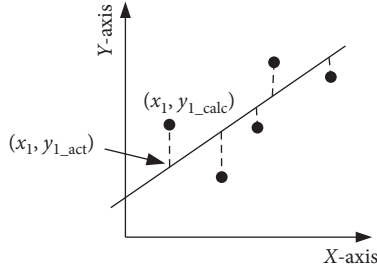

FIGURE 3: Coefficient of determination explanatory sketch.

- (3) Root mean square error (RMSE) is obtained by applying the square root to the MSE
- (4) Mean absolute percentage error (MAPE) is the average of absolute errors over the actual records

#### 4. Case Studies

A 25-kV distribution system (refer to Figure 4) is modeled in MATLAB/Simulink to verify the effectiveness of the three line parameters identification techniques. A total of 12,960 different case studies have been performed under six main loading scenarios (stated in Table 1) and four categories (presented in Table 2) with changing of the line parameters. The line parameters have been varied in 60 steps. The loading scenarios and categories considered under this study are tabulated in below tables.

The large number of case studies has been developed to test the robustness and accuracy of this paper proposals. The 12,960 simulations differ in the loading conditions, line lengths, noise, and inaccuracy mitigations.

The selected DL is modeled as three-phase DL with a  $\pi$ -type. The model consists of one set of resistance and inductance elements in series connected between sending and receiving terminals. Two sets of shunt capacitances lumped are, also, included at both ends as illustrated in Figure 1. The initial DL parameters are stated in Table 3.

The total series resistance, reactive inductance, and shunt admittance are given by the following formulas, respectively:

$$\begin{aligned} R &= r\ell, \\ X_{DL1} &= \omega L\ell, \\ Y_{DL} &= \omega C\ell, \end{aligned} \quad (14)$$

where  $R$ ,  $L$ , and  $C$  are the total DL resistance, inductance, and capacitance, and  $\ell$  is the total length of the line.

In MATLAB, two sets of simulated PMUs are placed at both terminals of the selected DL to measure the voltages and currents waveforms simultaneously. The recorded waveforms are in the shape of sinusoidal signals and then converted into phasor equivalents.

#### 5. Results and Discussions

The simulation results of the 12,960 cases are summarized in this section and organized into four categories. Under each category, the resistance, reactive inductance, and shunt admittance are calculated using the three methods for

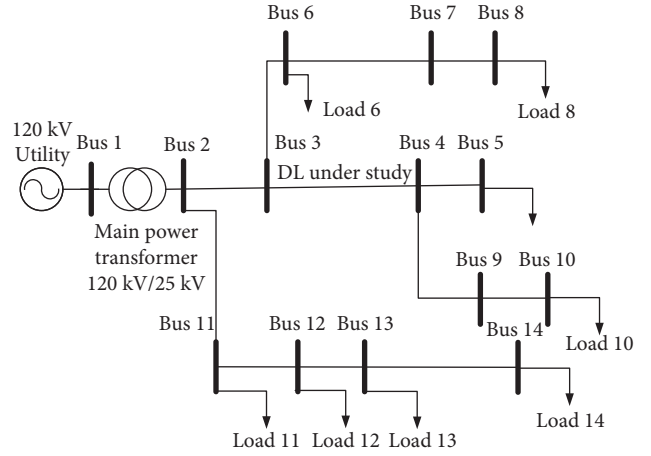

FIGURE 4: The 25 kV 14-bus test distribution network under consideration.

TABLE 1: The six loading scenarios for simulations.

Scenario	Load	
	Active (MW)	Reactive (MVar)
1	1	0.25
2	2	0.5
3	3	0.75
4	4	1
5	5	1.25
6	6	1.5

TABLE 2: The four categories for this study.

Category	Description
1	Phase quantities
2	Positive sequence quantities
3	Phase quantities with noise
4	Phase quantities with the proposed inaccuracy mitigation for noisy systems in category 3

TABLE 3: Initial parameters of the distribution line test circuits.

Parameter	Actual value	Dimension
$r$	0.1153	(Ohms/km)
$l$	1.05e-3	(H/km)
$c$	11.33e-009	(F/km)

where  $r$ ,  $l$ , and  $c$  are the resistance, inductance, and capacitance per unit length, respectively.

different loading conditions and parameter values. The calculation is based on the voltage and current signals obtained from PMUs that are installed at both ends of the line. Figure 5 shows the voltage and current signals obtained from PMU devices considering noise-free system.

**5.1. Phase Quantities.** In this category, the phase quantities of voltage and current are used to perform the analysis. This type of analysis is required for asymmetrical related studies such as unbalanced fault analysis.



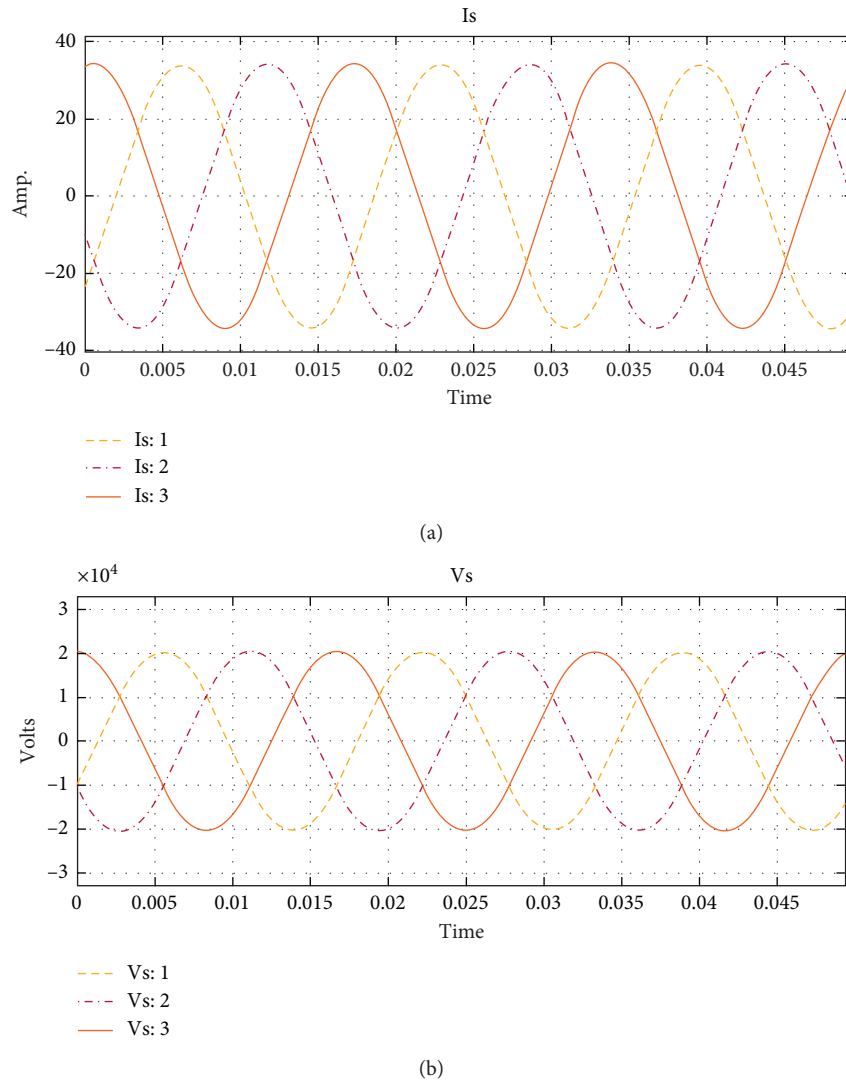

FIGURE 5: PMU current and voltage signals with noise-free.

The values of resistance, reactive inductance, and shunt admittance are changing in 60 steps. The parameters identification errors of the six loading scenarios are averaged for the three methods. The voltage and current waveforms are assumed to be noise-free. Results of the average errors for the resistance, reactive inductance, and shunt admittance are shown in Figure 6. The maximum errors for each method are stated in Table 4. The results reveal that SMT is more effective in calculating the DL parameters.

The TPCMT shows weakness in calculating the shunt admittance for short lines. This is expected as the method was developed specifically for medium transmission lines. However, it performs very well when the DL length is ranging between 10 and 30 km which is a common sort of DLs.

**5.2. Positive Sequence Quantities.** Both OFT and SMT have excellent performance in identifying the DL parameters using positive sequence quantities. The average and maximum errors recorded in the simulated studies are presented

in Figure 7 and Table 4, separately. It is observed from the results that TPCMT fails to calculate the line parameters using positive sequence voltage and current quantities. Therefore, the results were excluded from Figure 7. The results demonstrate that SMT is superior to OFT in calculating the line parameters using positive sequence quantities.

**5.3. Phase Quantities with Noise.** Actual voltage and current signals of any distribution system are not pure sinusoidal. Noise is always impeded in the signals due to several factors, e.g., harmonics produced from electronic based devices. The electronic devices could be at residential areas such as televisions, computers, laptops, electronic games, and so on. There are a number of applications that produce harmonics at the industrial sector, for example capacitor bank, variable frequency drives, and other electronic based equipment.

Accordingly, all input signals to PMUs will be associated with additional harmonics beside the fundamental frequency (60 Hz) as in the Kingdome power system.

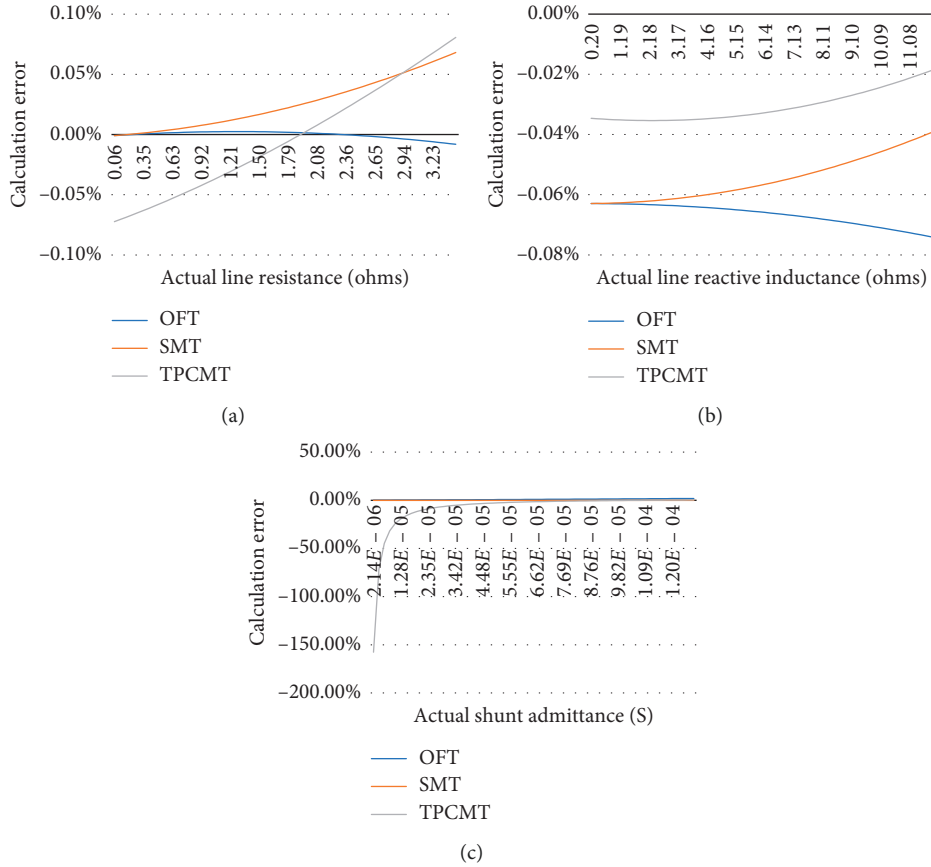

FIGURE 6: Calculation average errors of the six loading scenarios for the three methods under Category 1. (a) Resistance. (b) Reactive inductance. (c) Shunt admittance.

TABLE 4: Maximum errors of the six loading scenarios considering the variation of the line parameters.

Category	Method	R	$X_L$	$X_C$
1	1	0.04%	0.07%	3.35%
	2	0.09%	0.15%	0.07%
	3	0.12%	0.04%	High
2	1	0.11%	0.13%	3.45%
	2	0.08%	0.15%	0.11%
	3	High	High	High
3	1	0.45%	1.10%	2.22%
	2	0.38%	1.08%	<b>1.22%</b>
	3	1.87%	0.52%	High
4	1	0.34%	0.59%	1.49%
	2	0.34%	0.59%	<b>0.03%</b>
	3	0.10%	0.04816%	High

Although PMU measurements showed an improved accuracy compared to other devices, this performance is not fully materialized in the actual field due to errors from other channels such as instrumentation, CT, and potential transformer (shortly PT) and etc.

Figure 8 shows the voltage and current signals obtained from PMU devices considering noisy system.

The OFT and SMT have extraordinary performance when applying the phase values to noisy system (Figure 9). TPCMT

still shows weakness in estimating the line parameters, especially for short lines capacitance. As the line length increases as TPCMT converges for identifying the  $X_C$ .

The maximum error recorded in the simulated studies is shown in Table 4. From the calculated average and maximum errors of the six loading scenarios for the three methods considering phasor quantities, it is concluded that SMT is superior to the other techniques for noisy system.

#### 5.4. Phase Quantities with Inaccuracy Mitigation for Noisy Systems.

It is observed from the simulated case studies that the error follows specific trend under different line parameters, irrespective of the loading conditions. Knowing the error trend will ease predicting the error magnitude and hence mitigating it. This category proposes to apply inaccuracy mitigation measures to improve the line parameter calculation errors. The measures are developed based on line characteristics and possible loadings. The proposed inaccuracy mitigation measure concept is illustrated in Figure 10 and given by the following formula:

$$\ddot{y} = \dot{y}(1 + \varepsilon(\dot{y})), \tag{15}$$

where  $\dot{y}$  is the originally calculated value and  $\ddot{y}$  is the enhanced measurement. The symbol  $\varepsilon$  is taken from the

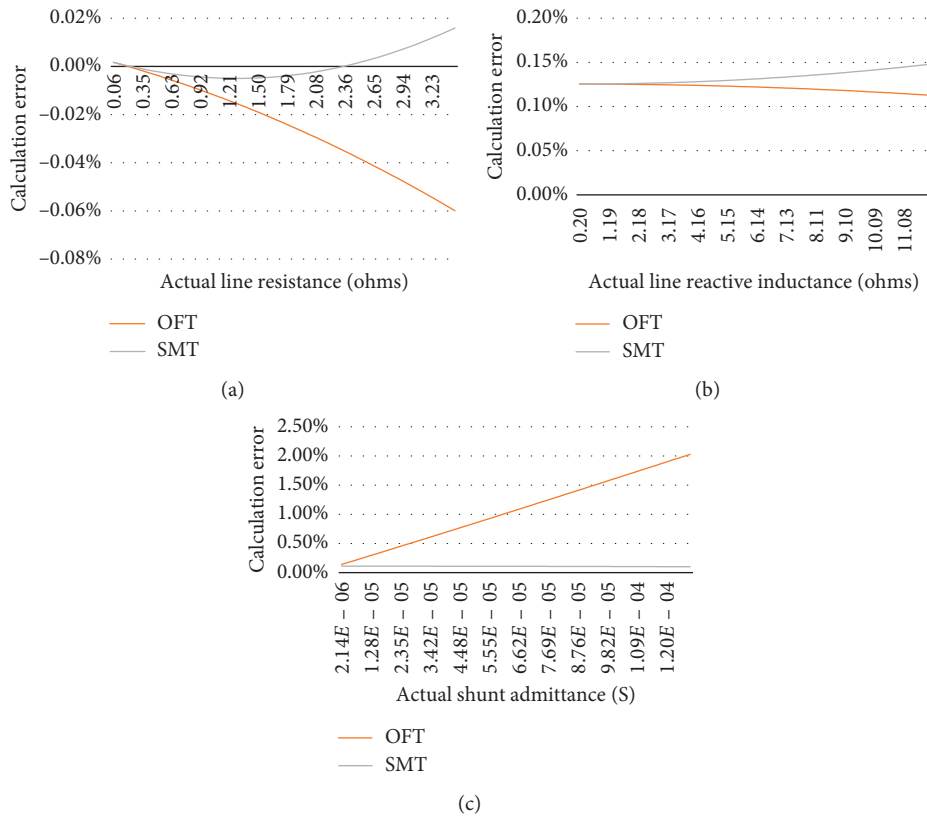

FIGURE 7: Calculation average errors of the six loading scenarios for the OFT and SMT techniques under Category 2. (a) Resistance. (b) Reactive inductance. (c) Shunt admittance.

predeveloped inaccuracy mitigation measures demonstrated in Figure 10. The inaccuracy mitigation curve could take different shapes based on line loading and characteristics.

The proposed concept has been applied to Category 3, and the simulation results are illustrated in Figure 11. The results reveal significant improvements of Category 4 compared to Category 3 in Figure 9.

The inaccuracy mitigation measures will result in accuracy improvement up to 98% of the maximum error of Category 3. The maximum errors for the four categories and six loading scenarios considering the variation of the line parameters are tabulated in Table 4.

The MAD, MSE, RMSE, MAPE, and CoD have been applied to the four categories and six loading scenarios. The results for the latter are averaged into one value for each category and parameter. The results are tabulated in Table 5 to evaluate the robustness of this paper proposals. It is noticed from the table that generally the values under the proposed inaccuracy mitigation measures category (Category 4) are improved compared to those in Category 3. This shows the strength of the proposed inaccuracy mitigation concept which could be applied for ideal and noisy systems. The use of positive sequence quantities will perform very well when using OFT and SMT. However, the phase quantities will result in more accurate line parameters estimation. Unlike OFT and SMT, TPCMT does not function when using the positive sequence values. Therefore, ABCD should not be used for any asymmetrical related studies in DLs.

MAPE is found to be the only method applicable for calculating the line shunt admittance since the values of the capacitances are very small scientific numbers.

## 6. Conclusions

To carry out any asymmetrical related analysis at DLs such as asymmetrical fault studies, the symmetrical components should be leveraged to identify the positive, negative, and zero sequences. Therefore, robust and accurate line parameters calculation techniques are required. Based on that, three line parameters identification techniques have been applied to different case studies and evaluated using different statistical measures. The outcomes of this analysis along with the associated recommendations are as follows:

- (1) The proposed inaccuracy mitigation concept will result in accuracy improvement up to 98% of the maximum error. Therefore, it is recommended to use this concept for any online impedance and admittance calculations using PMUs.
- (2) The inaccuracy of the line parameters estimation follows a specific trend over different scenarios. This will allow proper inaccuracy prediction and hence mitigation.
- (3) The proposed inaccuracy prediction and mitigation have resulted in a negligible deviation between



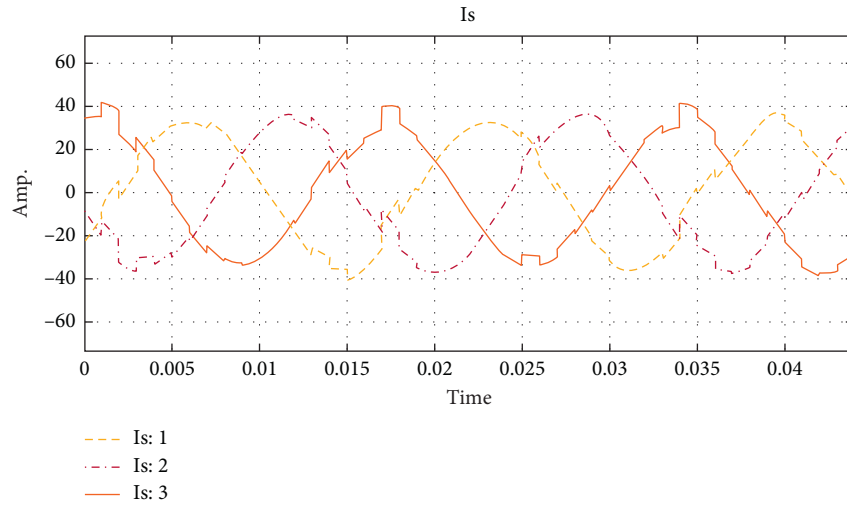

(a)

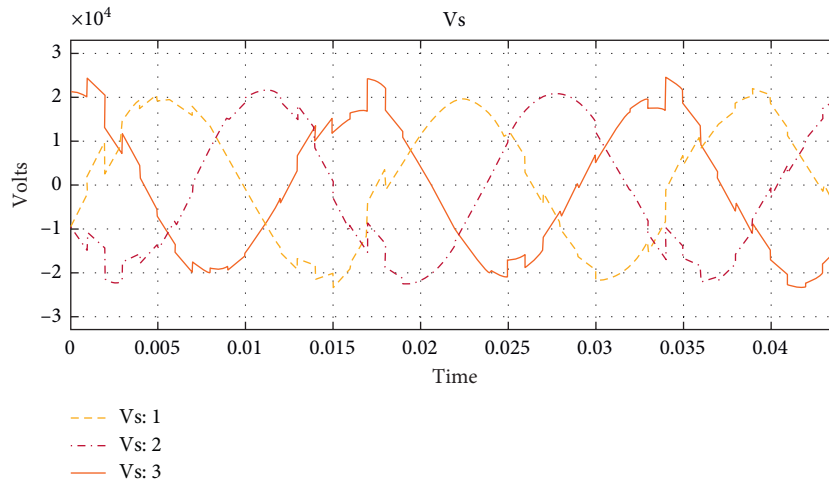

(b)

FIGURE 8: PMU current and voltage signals with noise.

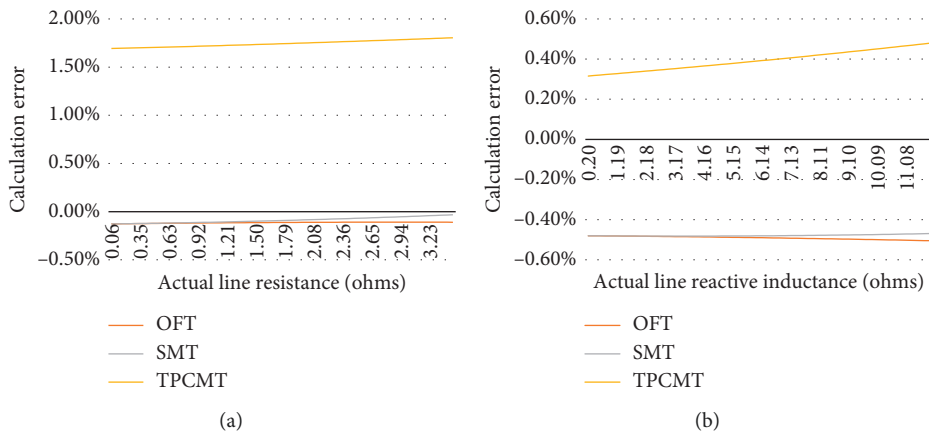

FIGURE 9: Continued.

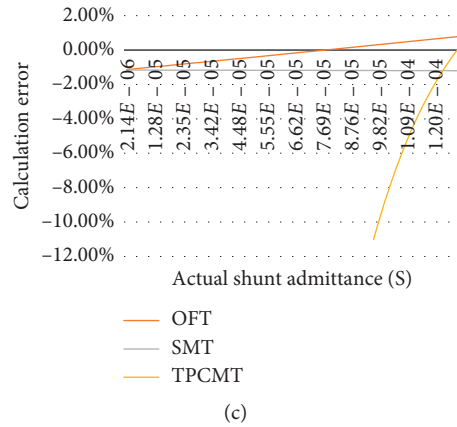

FIGURE 9: Calculation average errors of the six loading scenarios for the three methods under Category 3. (a) Resistance. (b) Reactive inductance. (c) Shunt admittance.

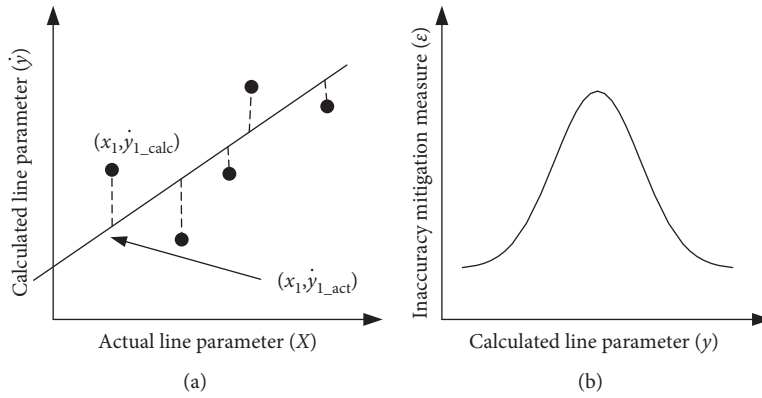

FIGURE 10: Indicative graphs of the proposed inaccuracy mitigation measure concept. (a) Actual vs. calculated line parameters. (b) Proposed inaccuracy mitigation measure.

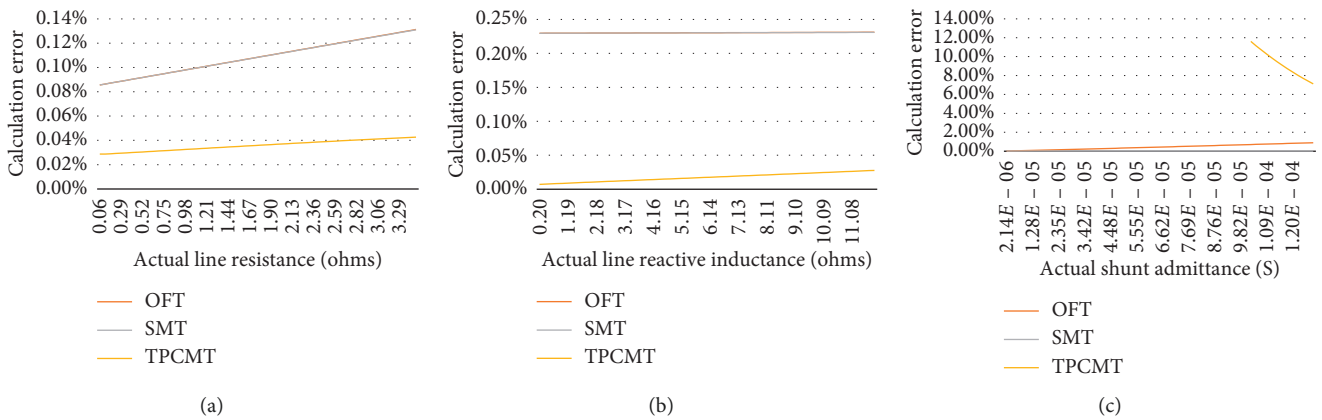

FIGURE 11: Calculation average errors of the six loading scenarios for the three methods under Category 4. (a) Resistance. (b) Reactive inductance. (c) Shunt admittance.

TABLE 5: Statistical measures results for all cases (%).

Parameter	Statistical measure	Method 1				Method 2				Method 3			
		1	2	3	4	1	2	3	4	1	2	3	4
Resistance	MAD	0.05	0.14	0.41	0.41	0.13	0.09	0.38	0.41	0.14	0.00	6.20	0.14
	MSE	0.00	0.00	0.00	0.00	0.00	0.00	0.00	0.00	0.00	0.00	0.26	0.00
	RMSE	0.04	0.14	0.34	0.34	0.14	0.08	0.33	0.34	0.15	0.00	5.07	0.12
	MAPE	0.02	0.06	0.24	0.22	0.05	0.04	0.22	0.22	0.08	0.00	3.49	0.07
	$R^2$	99.99	99.98	99.88	99.90	99.98	99.98	99.89	99.90	99.96	0.00	98.40	99.97
Inductance	MAD	0.83	1.44	5.97	2.78	0.61	1.65	5.76	2.78	0.34	0.00	5.08	0.25
	MSE	0.00	0.01	0.32	0.08	0.00	0.02	0.30	0.08	0.00	0.00	0.18	0.00
	RMSE	0.69	1.16	4.88	2.27	0.48	1.37	4.67	2.26	0.26	0.00	4.28	0.23
	MAPE	0.13	0.24	0.98	0.46	0.11	0.27	0.96	0.46	0.06	0.00	0.79	0.03
	$R^2$	99.99	99.99	99.96	99.98	100.0	99.99	99.96	99.98	100.0	0.00	99.97	100.0
Capacitance	MAD	0.00	0.00	0.00	0.00	0.00	0.00	0.00	0.00	0.00	0.00	0.01	0.04
	MSE	0.00	0.00	0.00	0.00	0.00	0.00	0.00	0.00	0.00	0.00	0.00	0.00
	RMSE	0.00	0.00	0.00	0.00	0.00	0.00	0.00	0.00	0.00	0.00	0.01	0.09
	MAPE	1.83	2.15	1.42	0.88	0.12	0.21	2.36	0.03	16.68	0.00	High	High
	$R^2$	Zero	Zero	Zero	Zero	Zero	Zero	Zero	Zero	Zero	Zero	Zero	Zero

calculated and actual DL parameters. This proves the robustness of the proposals of this paper.

- (4) Both OFT and SMT have extraordinary performance in calculating the DL parameters using positive sequence quantities. Therefore, it is recommended to use them for any asymmetrical based analysis such as unbalanced fault studies.
- (5) SMT is superior to OFT in calculating the line parameters using positive sequence quantities.
- (6) TPCMT does not perform when the line resistance is small (short line) and using phase quantities. This is expected as the method was developed for medium transmission lines. As the line impedance or length increase, TPCMT will boost up its resistance calculation accuracy.
- (7) It is expected the TPCMT will not perform very well for capacitance identification of short DLs. Therefore, it is unrecommended to use this method for short DLs.
- (8) TPCMT fails to produce result using positive sequence voltage and current signals. Therefore, it should not be applied for any asymmetrical studies at the distribution level.
- (9) Some statistical measures do not function under certain conditions, such as in case of small scientific figures. Therefore, there is a need for a wide range of statistical measures to ensure covering all study cases.
- (10) SMT is ranked to be the most robust technique for identifying all DL parameters under different conditions and OFT comes the second. Therefore, it is recommended to use SMT for any distribution related case studies.

## Data Availability

The data used to support the findings of this study are available from the corresponding author upon request.

## Conflicts of Interest

The authors declare that they have no conflicts of interest.

## References

- [1] R. E. Wilson, G. A. Zevenbergen, D. L. Mah, and A. J. Murphy, "Calculation of transmission line parameters from synchronized measurements," *Electric Machines and Power Systems*, vol. 27, no. 12, pp. 1269–1278, 1999.
- [2] D. Shi, D. J. Tylavsky, N. Logic, and K. M. Koellner, "Identification of short transmission-line parameters from synchrophasor measurements," in *Proceedings of 2008 40th North American Power Symposium*, pp. 1–8, Calgary, Alberta, Canada, September 2008.
- [3] D. Shi, D. Tylavsky, K. Koellner, D. Wheeler, and N. Logic, "Transmission line parameter identification using PMU measurements," *European Transactions on Electrical Power*, vol. 21, no. 4, pp. 1574–1588, 2010.
- [4] Y. Liao and M. Kezunovic, "Online optimal transmission line parameter estimation for relaying applications," *IEEE Transactions on Power Delivery*, vol. 24, no. 1, pp. 96–102, 2009.
- [5] A. M. Dan and D. Raisz, "Estimation of transmission line parameters using wide-area measurement method," in *Proceedings of 2011 IEEE Trondheim PowerTech*, pp. 1–6, Trondheim, Norway, June 2011.
- [6] I. W. Slutsker, S. Mokhtari, and K. A. Clements, "Real time recursive parameter estimation in energy management systems," *IEEE Transactions on Power Systems*, vol. 11, no. 3, pp. 1393–1399, 1996.
- [7] Y. Liao, "Algorithms for fault location and line parameter estimation utilizing voltage and current data during the fault," in *Proceedings of 2008 40th Southeastern Symposium on System Theory (SSST)*, pp. 183–187, New Orleans, LA, USA, March 2008.
- [8] D. Jia, W. Sheng, X. Song, and X. Meng, "A system identification method for smart distribution grid," in *Proceedings of 2014 International Conference on Power System Technology (POWERCON)*, pp. 14–19, Chengdu, China, October 2014.

- [9] G. D'Antona and M. Davoudi, "Effect of phasor measurement unit on power state estimation considering parameters uncertainty," in *Proceedings of 2012 IEEE International Workshop on Applied Measurements for Power Systems (AMPS)*, pp. 1–5, Aachen, Germany, September 2012.
- [10] R. N. Mahanty and P. B. Dutta Gupta, "Application of RBF neural network to fault classification and location in transmission lines," *IEE Proceedings-Generation, Transmission and Distribution*, vol. 151, no. 2, p. 201, 2004.
- [11] A. M. Prostejovsky, O. Gehrke, A. M. Kosek, T. Strasser, and H. W. Bindner, "Distribution line parameter estimation under consideration of measurement tolerances," *IEEE Transactions on Industrial Informatics*, vol. 12, no. 2, pp. 726–735, 2016.
- [12] M. M. J. Al-Khabbaz, *Fault Location in Power Distribution Grids using Phasor Measurement Units*, King Fahd University of Petroleum and Minerals, Dhahran, Eastern Province, Saudi Arabia, 2018.

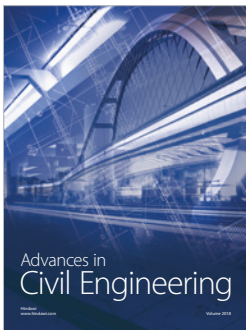
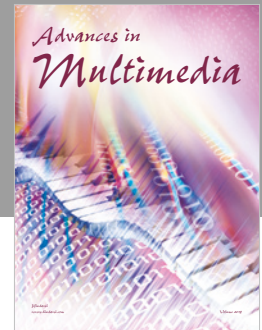
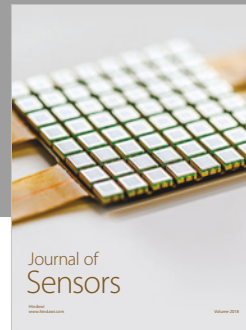
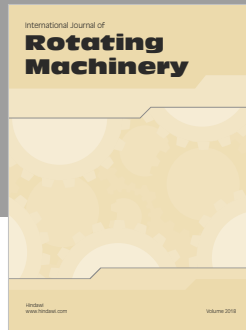

**Hindawi**

Submit your manuscripts at  
[www.hindawi.com](http://www.hindawi.com)

